

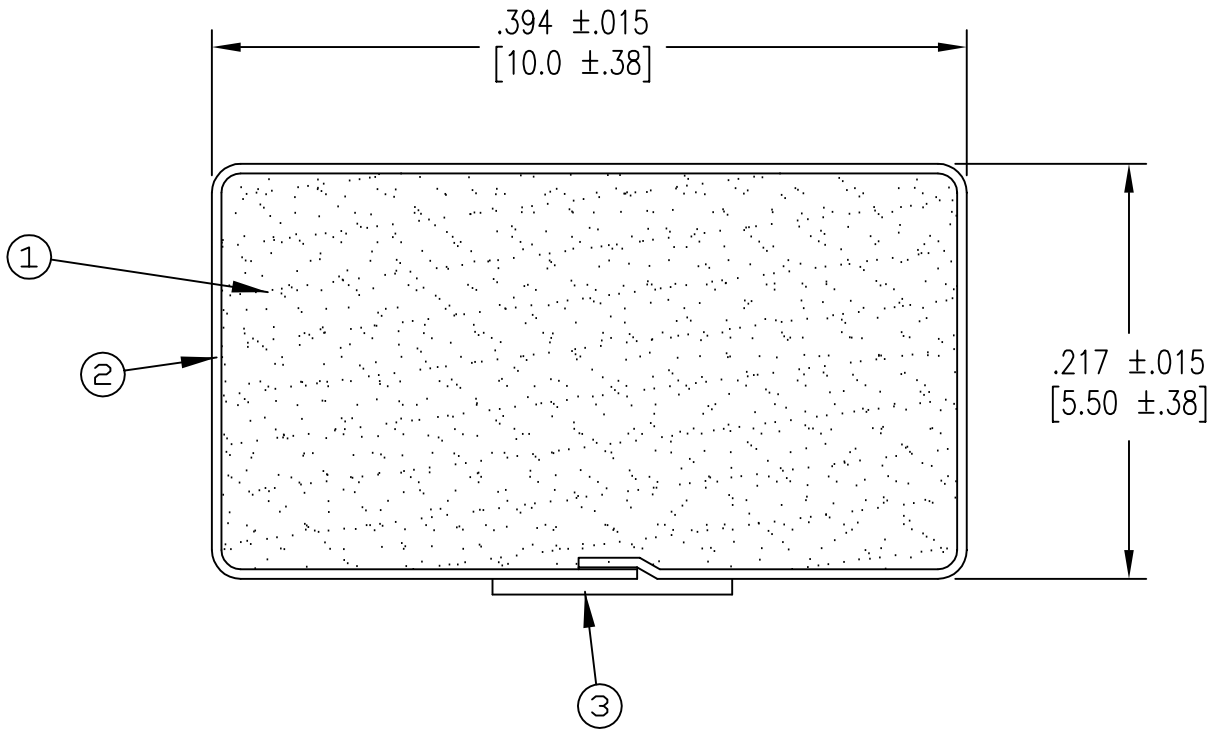

ROCHESTER DIVISION PRODUCT PRINT

The information disclosed on this drawing is confidential and the property of Schlegel Systems, Inc. The use, disclosure, or reproduction of this information and related knowhow is prohibited without written permission from Schlegel Systems, Inc.

Revisions			
Lev	Description	Date	By
(A)			
(B)			
(C)			



PDR 5477

DO NOT SCALE THIS DRAWING
UNLESS PRINTER IS QUALIFIED

FULL SCALE

DE0021FM.dwg

DECIMAL DIMENSIONS ± _____ UNLESS OTHERWISE SPECIFIED		(3)	SEE B.O.M.	PRESSURE SENSITIVE ADHESIVE .125" WIDE UNLESS OTHERWISE SPECIFIED
mm. <input checked="" type="checkbox"/>	Inch <input checked="" type="checkbox"/>	(2)	SEE B.O.M.	CONDUCTIVE FABRIC
Date: 1/11/2005		(1)	SEE B.O.M.	URETHANE FOAM
Sheet 1 of 1	Item	R.M. Number	Material Description	
Drawn Scale: 10 : 1	Approved:	Drawn: ED LEE	Title: 5.5MM X 10MM EMI	
Cad File No. UC38031	Part No. EN3__T_____	Dwg. No. UC3E3803		