

Revisions			
Level		Date	By
(E)	REV TO PRO E	5/4/99	EL
(F)	ADDED .33 REF DIMENSION	7/28/00	MJD
(G)	ADDED SHEET 4	7/25/02	EL
(H)	REV PER ECO 2288	5/30/03	EL
(J)	UPDATE SHEET FORMAT	6/4/09	BEP

ROCHESTER DIVISION PRODUCT PRINT

The information disclosed in this drawing is confidential and the property of Schlegel Electronic Materials, INC. The use, disclosure, or reproduction of this information and related know-how is prohibited without written permission from Schlegel Electronic Materials, INC.

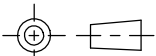
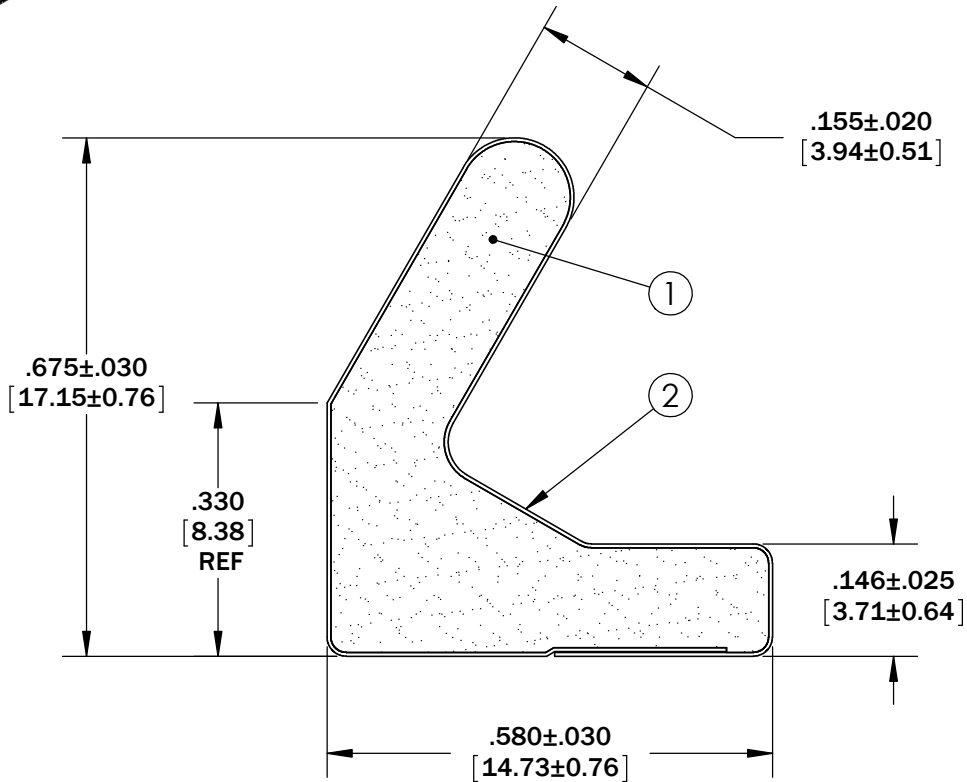
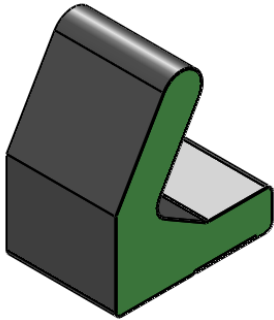

TOLERANCES  
 Profile thickness:  $\pm .030$ " (0.76mm)  
 Profile width:  $\pm .030$ " (0.76mm)

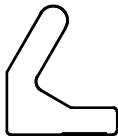

SCALE 1:1

PDR NO.:	(4)		
QUOTE NO.:	(3)		
CUSTOMER NAME:	(2)	SEE B.O.M.	CONDUCTIVE FABRIC
CUST DWG NO.:	(1)	SEE B.O.M.	URETHANE FOAM
SIZE A	Date	5/4/1999	
	SHEET 1 OF 4		Item No.
SCALE: 4:1	Approved By	Drawn By	EJL
		Title	17.1mm x 14.7mm C-FOLD EMI
Cad File No.	UP02841J	Part No.	E32
		Dwg. No.	UP3E0284
		Rev.	J

ROCHESTER DIVISION PRODUCT PRINT

The information disclosed in this drawing is confidential and the property of Schlegel Electronic Materials, INC. The use, disclosure, or reproduction of this information and related know-how is prohibited without written permission from Schlegel Electronic Materials, INC.

Revisions

Level		Date	By
(E)	REV TO PRO E	5/4/99	EL
(F)	ADDED .33 REF DIMENSION	7/28/00	MJD
(G)	ADDED SHEET 4	7/25/02	EL
(H)	REV PER ECO 2288	5/30/03	EL
(J)	UPDATE SHEET FORMAT	6/4/09	BEP

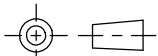
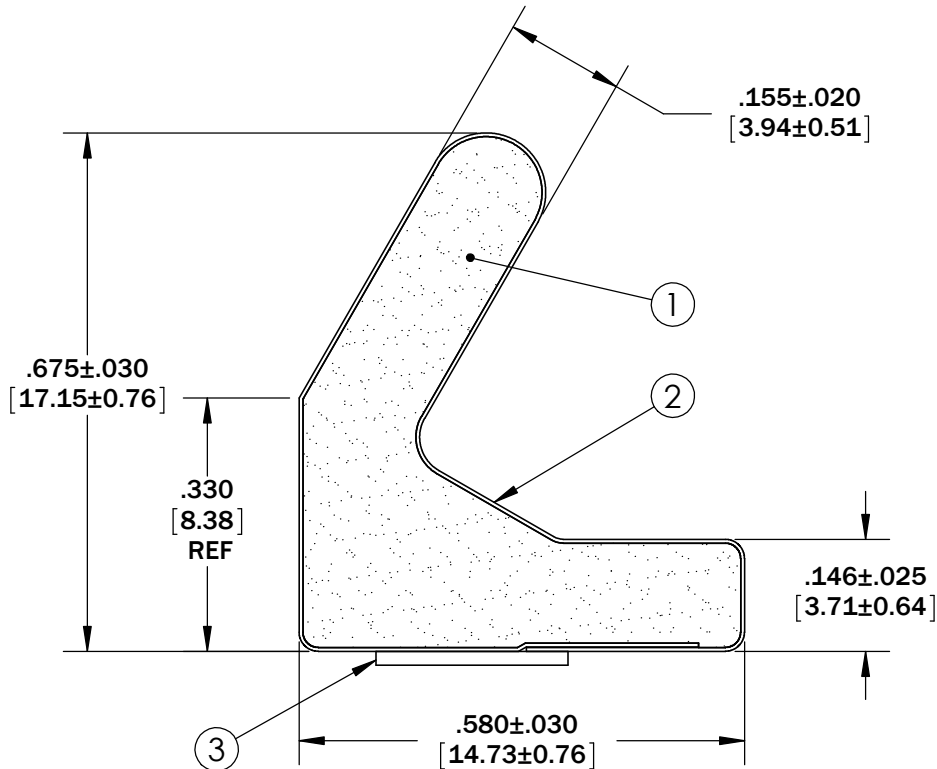
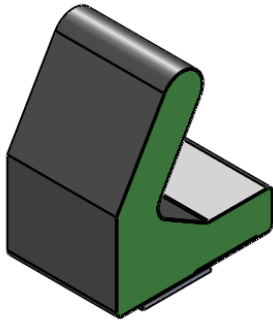

TOLERANCES

Profile thickness:  $\pm .030$ " (0.76mm)  
 Profile width:  $\pm .030$ " (0.76mm)

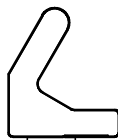

SCALE 1:1

PDR NO.:	(4)		
QUOTE NO.:	(3)	SEE B.O.M.	PSA .250" WIDE (UNLESS OTHERWISE SPECIFIED)
CUSTOMER NAME:	(2)	SEE B.O.M.	CONDUCTIVE FABRIC
CUST DWG NO.:	(1)	SEE B.O.M.	URETHANE FOAM
SIZE A	Date	5/4/1999	
SHEET 2 OF 4		Item No.	Material Description
SCALE: 4:1	Approved By	Drawn By EJL	Title 17.1mm x 14.7mm C-FOLD EMI
Cad File No. UP02841J	Part No. E32	Dwg. No. UP3E0284	Rev. J